

Cardiff Bath Bolton Lincoln Liverpool Glasgow York

Installation— and User guide

Revision 2

ENERG
енергия · ενεργεια

Y UA
IE IA
IE IA
IE IA

Varde Ovne A/S
Bolton, Cardiff
and Lincoln

A++
A+
A
B
C
D
E
F
G

A+

7,2
kW

ENERGIA · ЕНЕРГИЯ · ΕΝΕΡΓΕΙΑ · ENERGIJA · ENERGY · ENERGIE · ENERGI

2015/1186



Congratulation on purchasing your new stove

Varde Ovne A/S is a Danish company specializing in functional, environmentally friendly and designed quality stoves.

Index

| | |
|---|---------|
| Technical specifications YORK | Side 3 |
| Technical specifications CARDIFF | Side 4 |
| Technical specifications BATH | Side 4 |
| Technical specifications BOLTON | Side 5 |
| Technical specifications LINCOLN | Side 6 |
| Technical specifications LIVERPOOL | Side 7 |
| Technical specifications GLASCOW | Side 8 |
| Regulations and approval | Page 9 |
| Flooring and distance | Page 10 |
| Chimney | Page 11 |
| Operation | Page 12 |
| Fresh Air supply | Page 13 |
| How to light and stoke a fire | Page 14 |
| List of accessories | Page 15 |
| Vermiculite | Page 16 |
| How to choose the wood | Page 17 |
| Maintenance | Page 18 |
| Troubleshooting | Page 19 |
| Spare Parts | Page 20 |
| Test certificate (RWE) | Page 21 |
| Test certificate (Teknologisk Institut) | Page 22 |
| Warranty | Page 23 |

Technical Specifications

YORK

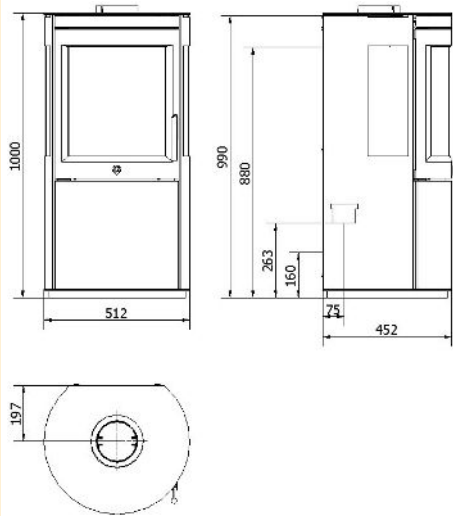

Model YORK

| | |
|-------------|------|
| Height (mm) | 1000 |
| Wide (mm) | 512 |
| Depth (mm) | 452 |
| Weight (kg) | 104 |

| | |
|----------------|----------------------|
| Nominal Output | 7,2 kW |
| Heated area | 60-160m ² |
| Efficiency | 80 % |
| EEl | 107 |

Flue gas data: 6,2 g/sek., 335°C ved 20°C, 12 pa.

Combustion chamber: (H x W x D):

440 x 440 x 360mm

Flue outlet Ø 15 cm (Mounting hight top:
~990cm)

Distance to non-flammable: : 5-10cm
(recommended)

Distance to flammable materials:

Rear = 20cm, Sides = 103cm, In front = 105cm

Technical Specifications

CARDIFF

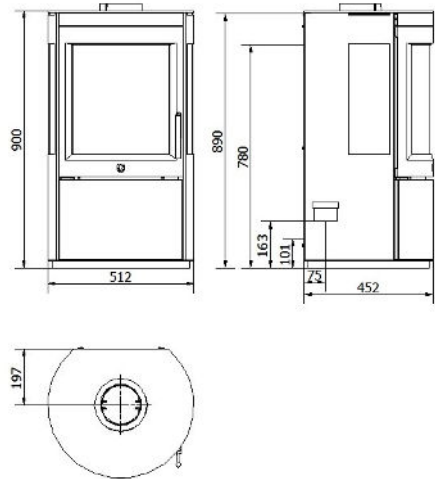

Model CARDIFF

| | |
|-------------|-----|
| Height (mm) | 900 |
| Wide (mm) | 512 |
| Depth (mm) | 452 |
| Weight (kg) | 100 |

| | |
|----------------|----------------------|
| Nominal Output | 7,2 kW |
| Heated area | 60-160m ² |
| Efficiency | 80 % |
| EEl | 107 |

Flue gas data: 6,2 g/sek., 335°C ved 20°C, 12 pa.

Combustion chamber: (H x W x D):

440 x 440 x 360mm

Flue outlet Ø 15 cm (Mounting hight top:
~990cm)

Distance to non-flammable: : 5-10cm
(recommended)

Distance to flammable materials:

Rear = 20cm, Sides = 103cm, In front = 105cm

Technical Specifications

BATH

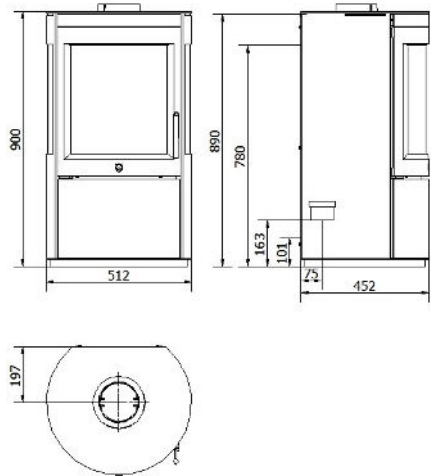

Model BATH

| | |
|-------------|-----|
| Height (mm) | 900 |
| Wide (mm) | 512 |
| Depth (mm) | 452 |
| Weight (kg) | 103 |

| | |
|----------------|----------------------|
| Nominal Output | 7,2 kW |
| Heated area | 60-160m ² |
| Efficiency | 80 % |
| EEl | 107 |

Flue gas data: 6,2 g/sek., 335°C ved 20°C, 12 pa.

Combustion chamber: (H x W x D):

440 x 440 x 360mm

Flue outlet Ø 15 cm (Mounting hight top:
~990cm)

Distance to non-flammable: : 5-10cm
(recommended)

Distance to flammable materials:

Rear = 20cm, Sides = 103cm, In front = 105cm

Technical Specifications

BOLTON

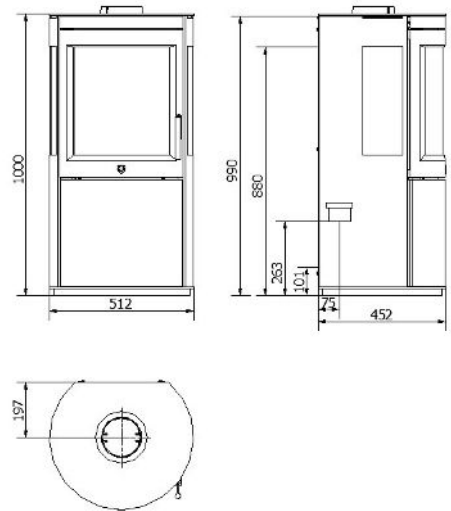

Model BOLTON

| | |
|----------------|----------------------|
| Height (mm) | 1000 |
| Wide (mm) | 512 |
| Depth (mm) | 452 |
| Weight (kg) | 100 |
| Effect | |
| Nominal Output | 7,2 kW |
| Heated area | 60-160m ² |
| Efficiency | 80 % |
| EEl | 107 |

Flue gas data: 6,2 g/sek., 335°C ved 20°C, 12 pa.

Combustion chamber: (H x W x D):

440 x 440 x 360mm

Flue outlet Ø 15 cm (Mounting hight top:
~990cm)

Distance to non-flammable: : 5-10cm
(recommended)

Distance to flammable materials:

Rear = 20cm, Sides = 103cm, In front = 105cm

Technical Specifications

LINCOLN

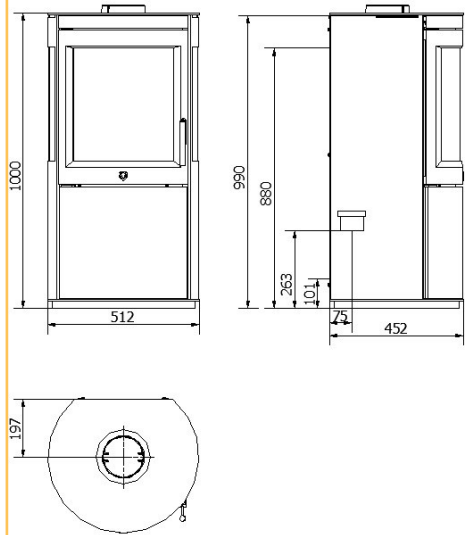

Model LINCOLN

| | |
|-------------|------|
| Height (mm) | 1000 |
| Wide (mm) | 512 |
| Depth (mm) | 452 |
| Weight (kg) | 103 |

| | |
|----------------|----------------------|
| Nominal Output | 7,2 kW |
| Heated area | 60-160m ² |
| Efficiency | 80 % |
| EEl | 107 |

Flue gas data: 6,2 g/sek., 335°C ved 20°C, 12 pa.

Combustion chamber: (H x W x D):

440 x 440 x 360mm

Flue outlet Ø 15 cm (Mounting hight top:
~990cm)

Distance to non-flammable: : 5-10cm
(recommended)

Distance to flammable materials:

Rear = 20cm, Sides = 103cm, In front = 105cm

Technical Specifications

LIVERPOOL

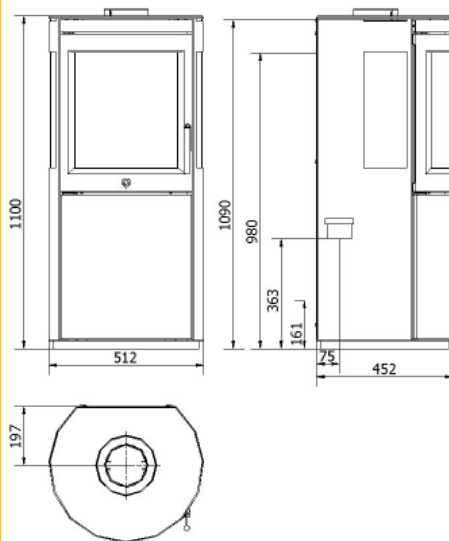

Model LIVERPOOL

| | |
|-------------|------|
| Height (mm) | 1100 |
| Wide (mm) | 512 |
| Depth (mm) | 452 |
| Weight (kg) | 100 |

| | |
|----------------|----------------------|
| Nominal Output | 7,2 kW |
| Heated area | 60-160m ² |
| Efficiency | 80 % |
| EEl | 107 |

Flue gas data: 6,2 g/sek., 335°C ved 20°C, 12 pa.

Combustion chamber: (H x W x D):

440 x 440 x 360mm

Flue outlet Ø 15 cm (Mounting hight top:
~1090cm)

Distance to non-flammable: : 5-10cm
(recommended)

Distance to flammable materials:

Rear = 20cm, Sides = 103cm, In front = 105cm

Technical Specifications

GLASGOW

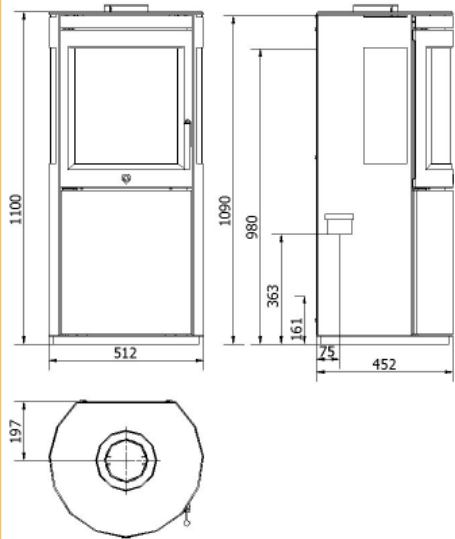

Model GLASGOW

| | |
|-------------|------|
| Height (mm) | 1100 |
| Wide (mm) | 512 |
| Depth (mm) | 452 |
| Weight (kg) | 103 |

| | |
|----------------|----------------------|
| Nominal Output | 7,2 kW |
| Heated area | 60-160m ² |
| Efficiency | 80 % |
| EEl | 107 |

Flue gas data: 6,2 g/sek., 335°C ved 20°C, 12 pa.

Combustion chamber: (H x W x D):

440 x 440 x 360mm

Flue outlet Ø 15 cm (Mounting hight top:
~1090cm)

Distance to non-flammable: : 5-10cm
(recommended)

Distance to flammable materials:

Rear = 20cm, Sides = 103cm, In front = 105 cm

Important!

Before lighting up your **Varde Stove** for the first time, we recommend that you read these instructions carefully and contact your local stove vendor or building authorities to inquire about existing regulations regarding the intallation of stoves. Please follow these regulations closely.

Inspection of installation

It is very important that the installation is inspected by a qualified chimney sweeper before the stove is used the first time.

This Varde Stove

Has passed the Danish /European Standard DS/EN 13240 Norwegian (NS) and the German (Stufe 2) test , and have thereby proved to be a environmentally friendly product.

Regulations

All local regulations as well as National and European, should be adhered to when installing your stove.

All Varde Ovne stoves are closed fireplaces.

The stove is designed for intermittent combustion and can not be connected to a chimney used by other fireplaces.

The roomheater is not suitable for installation in a shared flue system.

Professional installation

We recommend that you consult with the dealer where you purchased the stove or an other competent installer, as there may be specific things to consider during the installation. You should also reseive the applicable rules for installing the stove and follow them.

Please Note!

You are by law required to register your stove at the local chimney-sweeper.

Until installation keep the stove dry and not to cold. The stove cannot stand moisture. That an existing chimney, not necessarily is effective enough for a new modern stove. Vermiculite is a very porous material, therefore handle with care. When refilling the stove, put the wood carefully, use the glove.

EC declaration of confirmaty.**MANUFACTURER**

Name: **Varde Ovne A/S**
 Adress: Soldalen 12, DK-7100 Vejle, Danmark

Pejse Inspektion

Name: **Rhein-Ruhr Feuerstätten Prüffstelle GmbH**
 Adress: Im lipperfeld 34b, 46047 Oberhausen, Germany

Product

Product type: Varde York, Cardiff, Bath, Bolton, Lincoln, Liverpool, Glasgow
 Type code: Varde Luna
 Standard: Heating stove, suitable for intermittent combustion
 Construction products (89/106/EC/) standard used
 EN 13240
 Application: Residential Heating
 Fuel: Wood
 Special conditions: Non

CE-Markning

Issued: 2016
 Nominal Output: 7,2 kW
 Fuel type: Wood
 Fluegas temperature: 279 °C
 Efficiency: 80 %
 Co-release: 0,09 %



Jan Meldgaard
 Varde

Flooring:

If the floor on which the stove is to be placed is inflammable, the floor must be covered with non-flammable material, such as steel or glass plate, floor tiles or artificial slate, covering an area of at least 15 cm from the sides of the stove and at least 30 cm from the front of it. Regarding the front, however, we recommend 50 cm. Also, the Floor construction must be capable of carrying the combined weight of stove and chimney.

| Varde UK variant | York | Cardiff | Bath | Bolton | Lincoln | Liverpool | Glasgow |
|------------------|--------|---------|--------|--------|---------|-----------|---------|
| Weight | 104 kg | 100 kg | 103 kg | 104 kg | 106 kg | 107 kg | 107 kg |

Installation distance:

If walls are non-inflammable, the stove can be placed closer to them. However, we recommend a minimum distance of 5-10 cm, to allow for cleaning behind the stove. The cleanout gate must be accessible. Optimal combustion can only be obtained if fresh air is constantly admitted. It is important, therefore, to ensure that this is the case. The best way to provide a steady flow of fresh air is by installing 1-2 air vent's in the room where the stove is situated. (One in each side of the room).

According to existing regulations, stoves must be placed with the following minimum distances in mm to inflammable walls and materials. The safety distance from a non-insulated chimney pipe to inflammable walls and materials must be at least 450mm.

Varde Uniq

| | | | |
|---|--------|---|---------|
| A | 130 mm | C | 1030 mm |
| B | 200 mm | D | 1050 mm |

The stove must in accordance with applicable rules comply with the following minimum distances from inflammable walls and materials:

Side : 103 cm

Rear : 20 cm / 13 cm with insulated flue gas pipe

Distance to furniture : 105 cm

Flammable walls and materials

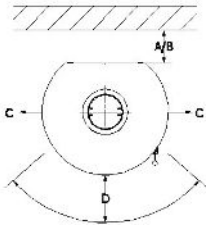

Non-flammable wall and materials

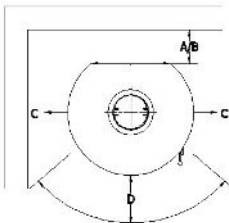

The chimney:

Always use a chimney with a diameter of at least 15 cm. This corresponds to a clear of 175 cm². Make sure the chimney is of a sufficient height, that it draws well and that smoke does not bother your neighbours.

We recommend that you fit your chimney with a damper, allowing for draft control. This may prove particularly important on windy days.

Note: the damper must never shut off draught completely – always allow at least 20 cm² free passage through the chimney.

With nominal usage the stove has tested a flue gas flow of 6,2g/second and with a flue gas temperature of 335°C and at a room temperature of 20 °C.

Varde stoves are always fitted with a smoke plate which redirects smoke to make its way to the chimney as effectively as possible. This ensures that the heat from the smoke is emitted inside your home rather than outside it. The smoke plate is moveable and placed in top of the Combustion Chamber. You should make sure that it is pushed all the way back against the back wall of the combustion chamber.

This roomheater is permissible for installation in a shared flue system.

Draught conditions

Consult your local stove dealer about how best to adjust the draught in your chimney.

Hight of chimney

If in doubt, contact your local stove dealer. He will be able to inform you of the correct hight.

Connection of Flue pipe:

The Stove is mounted with Flue adaptor on top or on the rear side.

When mounting on the rear side the Flue adaptor and cover switch places. The cast iron cover (not included in all stoves) is placed in the hole on top of the cast iron top.

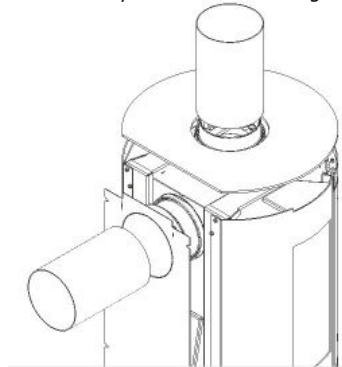

Information about the new cast iron flue adapter

Your stove is equipped with the new cast iron adapter from Varde Ovne.

The adapter is suitable for smoke pipes with inner diameter on 150 mm.

If you need it, it's now possible for you to make a condensate drain-hole in the adapter.

Carefully punch a chisel or the like through the bottom of the outer groove (at the

Arrow mark for the hole.

Carefully punch a hole with a chisel or the like.

Now the condensate – hole is ready.

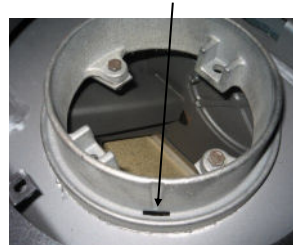
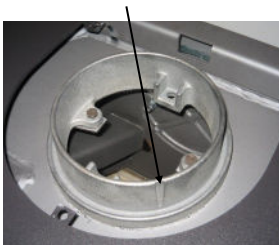

How it works – Operation

Ignition air Lighting your Varde Ovne stove

The Air supply is closed when the handle **1** is pushed back. Pull the handle towards yourself.

Your stove is now in ignition position.

Once the fire has caught properly, push handle **1** inn. Your stove is now in operating position. Wait until the fire burns bright and clear.

In the operating position you adjust the fire/heating by shifting the position of lthe handle **1** inn and out.

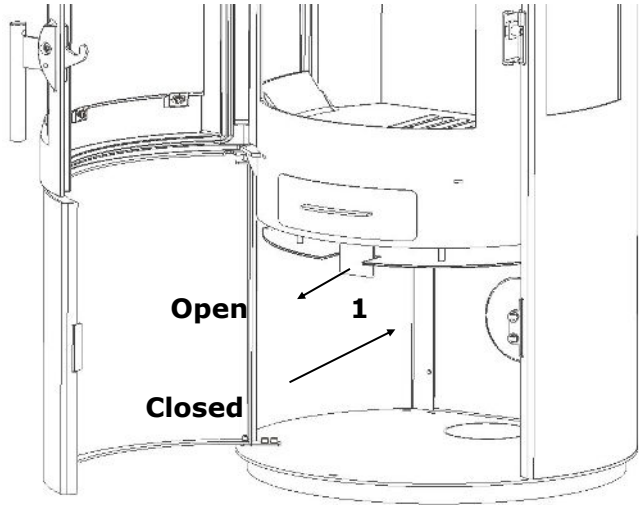

Overheating

Occurs if too much wood is placed in the stove or if the combustion receives too much air.

Attention! Storage shelf, in which no combustible materials can be mounted.

Continual fresh air.

A continual supply of fresh air is required in the room in which the stove is situated. This can be achieved by installing 1 or 2 vents, whilst also ensuring that these can not be blocked.

Combustion air supply (extra)

When a stove is installed in a room, the requirements to air supply increase. The air can be supplied through a vent in the outer wall or through a duct from the outside that is attached to the connector underneath the stove. The quantity of air needed for combustion is approx. 20 m³/h.

The spigot has an outer diameter of 67 mm. With pipes longer than 1 m the pipediameter has to be increased to 100 mm, and equivalent larger wall vent is chosen.

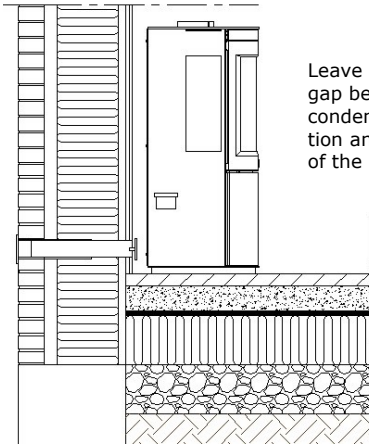

Indirectly through the exterior wall

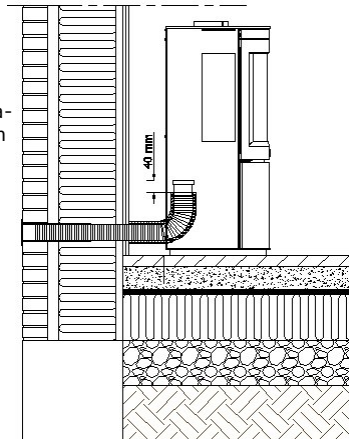

Through the exterior wall

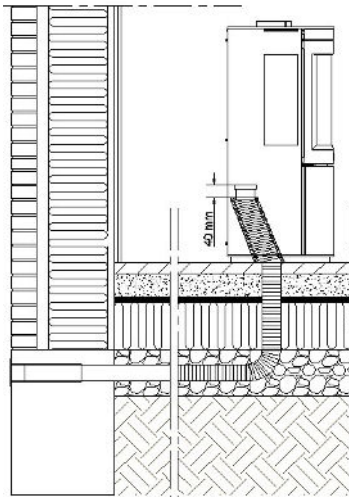

Through the floor and foundation

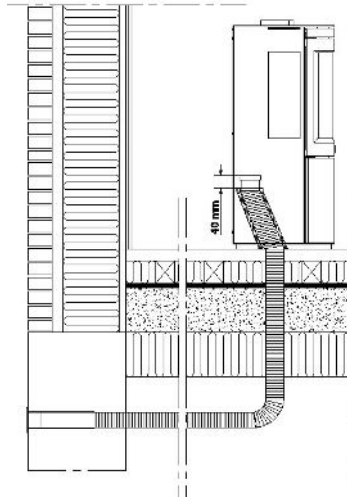

Through the floor and crawl space

How to light and stoke a fire

The first time you light up the stove, the enamel will temper and give off some smoke and a slightly burnt smell. We recommend that you leave doors and windows open, as airing the room will make the smell disappear.

This tempering softens the enamel, making it susceptible to damage. Therefore exercise caution and avoid touching the enamel. We also recommend opening the door to the stove at regular intervals during the first couple of hours to prevent the rope seal from sticking to the enamel.

Never use highly flammable liquids such as methylated spirit or petrol for lighting up!

We recommend using 'top-down' lighting, where you light the wood at the top of the combustion chamber and not at the bottom. This is the most environmentally friendly method to light a fire. The method will also help keep the glass clean. Place two small logs in a cross on the bottom plate of the combustion chamber (approx. 0.6 kg) with a small distance between each log. Place 10 – 15 smaller sticks (approx. 1.2 kg) in a cross on top of the logs, and 1-2 firelighters at the top and in between the sticks.

A thin layer of ash at the bottom of the stove makes it easier to light the fire.

Before lighting the stove, open the **ignition air** (See page 13 for how)

Once the fire burns, remember to close the ignition air vent and shaking grate again. Otherwise, the stove and chimney might become overheated, which would invalidate the warranty.

A slight amount of soot may build up on side glass during the start-up fire. This is normal and vanishes after a period.

Once the kindling has reduced to embers, we recommend opening the door slightly for a couple of seconds to neutralise the negative pressure in the combustion chamber before opening the door completely.

Place 2 logs in a cross on top of the embers (approx. 1.3 kg) and close the door again. To make sure the wood ignites quickly, we recommend briefly opening the ignition air vent and make sure you remember to close it again once the fire gets going. You can then adjust the combustion air according to your heating requirements.

Take care not to shut off the air supply completely, otherwise the fire will die. The fire should always burn bright and clear.

In most instances, however, you will have to identify the **best combustion air settings** yourself, as the height and draught of your chimney as well as the quality of the firewood are decisive factors in determining the best settings for your particular stove.

If the nominal heat output of your stove is too high compared to your heating requirements, you can reduce the output as follows:

- Stoke a smaller amount of wood than usual, for example 1 kg, preferably consisting of 3 – 4 smaller pieces of wood. Apply full air to ignite the wood properly before reducing the combustion air, perhaps down to approx. 60%. Be careful not to reduce the air supply to the point that the fire dies. The fire should always burn bright and clear.

With this method it is possible, depending on the chimney, wood quality, etc., to reduce the stove's heat output from a nominal 7 kW down to perhaps 4 kW.

Please be aware that it can lead to poor combustion if you reduce the combustion air too much, resulting in a lower efficiency and increased emission levels (increased pollution).

When refilling the stove with wood, we recommend opening the stove door once only embers are left in the combustion chamber. Opening the door while flames are still burning and producing smoke and gas might cause smoke to escape into the room.

If you have problems lighting or operating the stove, see the section on **Troubleshooting**.

Operation

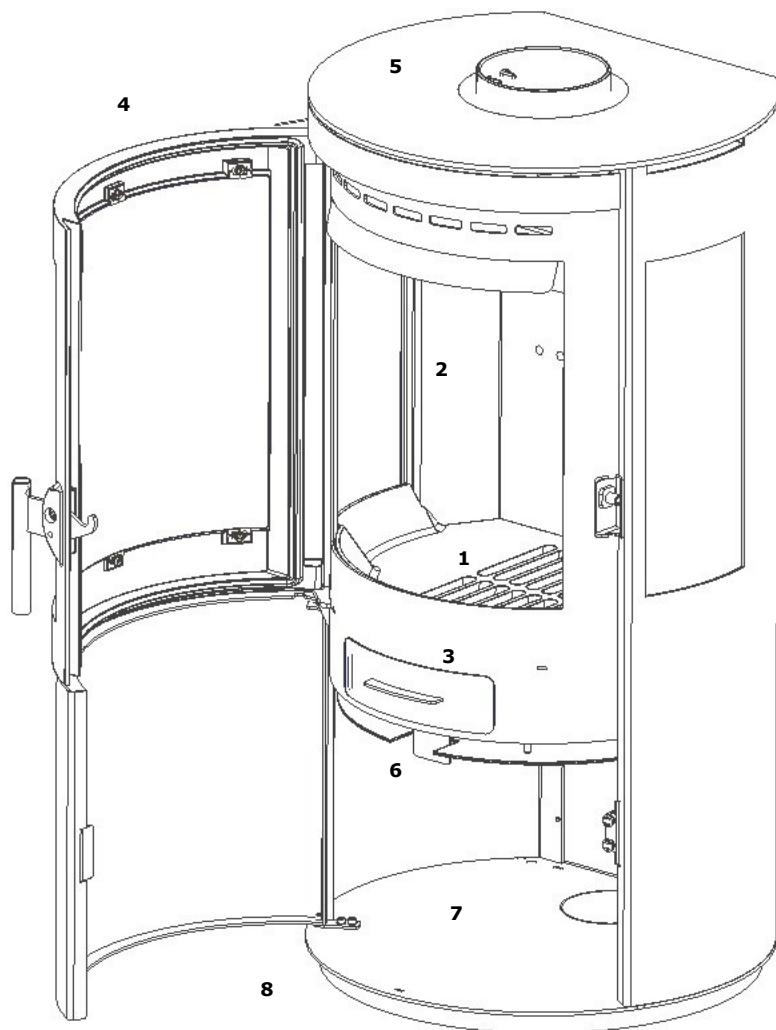

1. Grate
2. Vermiculit plates
3. Ash tray
4. Cast iron Door
5. Top
6. Throttel for Ignition Air and Combustion Air
7. Storage shelf, in which no combustible materials can be mounted.
8. Plinth

Vermiculite

The plates in the combustion chamber are called **vermiculite plates** and will eventually become worn, as will the smoke guide plate. Accidental breakage of a plate, for instance by hitting it hard with a piece of wood, will not affect the quality of the combustion. You do not need to replace the plate until the gap is approx. 5 mm wide.

Vermiculite

A special, non-flammable material that looks like chipboard. The plates act as insulation and at the same time protect the stove against wear and tear. The vermiculite plates and the smoke guide plate are not covered by the warranty.

Vermiculite is a **very porous** material and should be handled with care. When refilling the stove, stoke the wood carefully and use a glove.

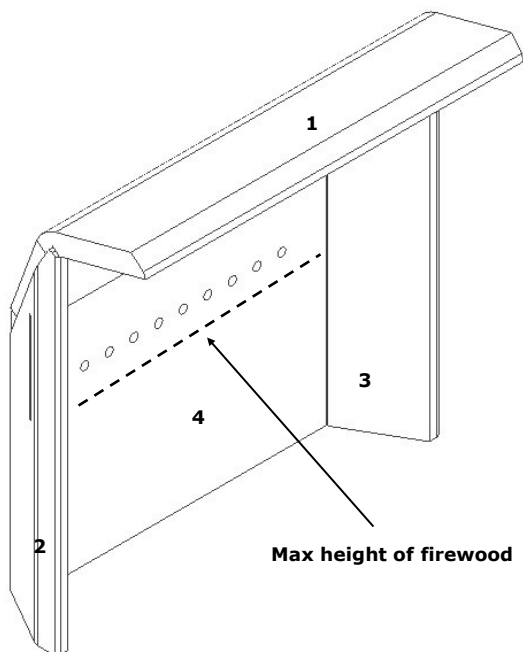

Only use original parts from Varde Ovne A/S

Vermiculite set see Spareparts list, page 21

- 1. Smoke guide plate**
- 2. Left side plate**
- 3. Right SidePlate**
- 4. Rear**

How too replace the Vermiculite

- 1.** Lift the smoke deflector plate slightly, tilt the rear end forward and remove.
- 2.** Lift the left side plate slightly and rotate outwards.
- 3.** Lift the right side plate and rotate outwards.
- 4.** Lift the rear plate up and out of the stove.

When fitting the new vermiculite plates, begin with the rear plate and repeat the steps in the reverse order, finishing with step 1

What kind of wood to use?

Generally, beech wood is considered the best type of wood for burning. It burns evenly without producing much smoke and ashes are clean and take up little space. Ash, birch and maple wood are fine alternatives.



How big the firewood?

Split firewood with a diameter larger than 10 cm. Use firewood with a length on 20-25 cm. The use of larger quantities of fuel than recommended in the tabel below will overtax the stove and resulte in increased temperatures in the chimney as well as a lowered efficiency. This may cause damage to both chimney and stove, and the annulment of the warranty. Also, never use toxic materials such as chipboard, painted or impregnated wood.

Kindling

Lenght: 25 -30 cm
Diameter: 2-5 cm
Amount per firing: 1,8 kg
(approx. 10-12 finely chopped pieces)

Feeding Wood: Chopped wood

Lenght: 25-35 cm
Diameter: 7-9 cm
Normal amount: 1.3 kg/hour (2 pieces)
Max amount: 2.0 kg/hour (max 3 pieces per insertion. Max 1.5 kg per insertion)

The following optimal register and fuel quantity settings are recommended(in case of similar chimney draught):

| Fuel Quantity [kg] | Primary Air open [%] | Combustion Air open [%] | Nominal Output [kW] | Chimney Draught [PA] | Efficiency [≥ i %] | Refill interval at nominal output [minuts] |
|--------------------|----------------------|-------------------------|---------------------|----------------------|--------------------|--|
| 1,3 | 0 (closed) | ca. 60 | 7 | 12 | 80 | ca. 45 |

The new stove

The first time you light up the stove the enamel will temper, and give off some smoke and a slight smell. We recommend that you leave doors and windows open, as airing the room will make the smell disappear. This tempering softens the enamel making it susceptible to damage. Therefore exercise caution and avoid touching the enamel. Likewise we recommend opening the door to the stove at regular intervals for the first hours to prevent the insulations rope from sticking to the enamel.

What to burn.

This Varde Stove is tested and approved for the burning of wood. Only dry wood with a moisture content of maximum 21 percent and the size to fit into the combustion chamber should be used. The burning of moist wood will result in an increased amount of tarry soot, pollution and uneconomic fuel consumption. Newly chopped wood contains about 60-70 percent moisture, which makes it completely unsuitable as fuel. Allow newly chooped firewood to dry in a open shed for a couple of years before using it in the stove.

Do not use! - Consider the environment

Also, never use toxic materials such as chipboard, painted or impregnated wood.

The use of larger quantities of fuel than recommended in the tabel below will overtax the stove and resulte in increased temperatures in the chimney as well as a lowered efficiency. This may cause damage to both chimney and stove, and the annulment of the warranty.

Topdown lightning



Maintenance

Like any piece of equipment in daily use, your stove needs maintenance.

The stove should only be cleaned when cold. Use a dry cloth for cleaning the exterior of the stove.

Clean the interior regularly by removing ashes, soot and tar from the combustion chamber. The smoke deflector plate should be removed for cleaning, as the reverse side will be covered in dirt and soot. Finally check that the smoke pathway through the flue pipe and chimney is completely clear. You should also inspect the rope seals in the door and ash pan for signs of wear. Replace them if they no longer seal properly. Also, remember to lubricate the door hinges as required.

Glass pane

The glass pane should be cleaned using Varde Glas Cleaner, which is available at all DIY centres selling **Varde Ovne stoves**.

Empty the **Ash pan** regularly. It can be emptied into your dustbin, as long as you make sure it does not contain any hot embers. If in doubt about how to clean your stove, contact the dealer where you bought your stove, or your chimney sweeper.

It is especially important to check the stove and the chimney for blockages after a long period of non-use.

The enamelled surface of the stove may wear down in certain places if the stove is **overheated**. Worn surfaces can, however, be repaired with a special Senotherm[®] spray paint, available from your local dealer.

The plates in the combustion chamber are **vermiculite plates** and will eventually become worn, as will the smoke deflector plate. Accidental breakage of a plate, for instance by hitting it hard with a piece of wood, will not affect the quality of the combustion. You do not need to replace the plate until the gap is 5 mm wide.

Only use original parts from Varde Ovne A/S

The door is equipped with a spring, which pulls the gate closed. This is a legal requirement in many countries. The spring is fitted to the hinged side of the door but can be removed if you prefer the door not to be spring-loaded.

Do not make any unauthorised changes to the stove.

All external parts of the stove become hot during use, and you should therefore exercise due caution.

IMPORTANT!!

Chimney fires

Should your chimney catch fire, cut off the air supply to the stove's combustion chamber and contact the emergency service. (The majority of fires die out after the oxygen supply is cut off.) You should subsequently contact your chimney sweeper, who will check your stove and chimney for damage

Troubleshooting.

Smoke enters the room

- Not enough draught in the chimney.
- Inspect the flue pipe or the chimney for blockage.
- Make sure the **height of the chimney** is correct.

The glass or the chimney soots up

- The wood is too moist.
- Not enough secondary air is supplied to the combustion process.
- You may have shut off the supply of ignition air too soon when lighting the stove.
- There should be clear flames in the combustion chamber at all times.

No heat is emitted from the stove

- The wood is too moist (all energy is spent on drying it) or of a poor quality.
- Inspect the position of the smoke deflector plate and make sure there is free passage for the smoke.
- The amount of combustion (secondary) air is insufficient.

Combustion is too intense

- Rope seals in the door or the ash pan are no longer tight and need replacement.
- The chimney draught is too strong; install a damper in the chimney.
- Check that the ignition air is shut off.

The shaking grate is stuck

- Inspect the grate for jammed wood, nails or the like.
- Make sure the lever is placed correctly.

Recycling



Packaging

For environmental reasons, the packaging should be disposed of together with household waste. The packaging is 100% recyclable.

Ceramic glass

Ceramic glass should be deposited at the local recycling centre (together with pottery and porcelain).

Vermiculite

Vermiculite plates from the stove should be deposited at the local recycling centre.

Spare Parts

If Spare parts at any time should be needed, please check the list below.

Vermiculit Set, UK versions, W-O side Windows, Item no.: 100775
Vermiculit Set, UK versions, W. Side windows, Item no.: 100740

Glass inside Combustion Chamber:

Front glass UK versions, Item no.: 100741

Side glass, UK versions, Item no.: 100742

Sealings:

Sealing rope Ø10 mm/2 m, (6pcs./crt) Item no.: 100442

Sealing rope 3 x 8 mm/2m, (6pcs./crt) Item no.: 100443

Braided Steel Ø6 mm/2 m, Item no.: 100347

Door complete, UK versions, Item no.: 100772

Spring for Door, UK versions—Thurø Item no.: 100787

Door handel, UK versions, Item no.: 100777

Magnet for lower door, UK –Aura1&2-Shape-US Item no.: 100788

Ash pan complete, UK versions, Item no.: 100776

Glas holders, UK version, One window, Item no.: 100784

Bottom complete, UK versions, W side windows, black.: Item no.: 100778

Bottom complete, UK versions, W-O side windows, black.: Item no.: 100781

Cover Plate, cast iron, Glasgow, Bolton, Lincoln, black.: Item no.: 100785

Cast iron top plate, Glasgow-Bolton-Lincoln Cover, black.: Item no.: 100786

- Rhein-Ruhr Feuerstätten Prüfstelle • Im Lipperfeld 34 b • 46047 Oberhausen
- ◆ Anerkendt prøveinstitut, godkendt af Europakommissionen (EU) Nr. 305/2011, notified body: 1625
 - ◆ Prøveinstitut efter DIN EN ISO/IEC 17025:2005, DAkkS Nr. D-PL-17727-01-00
 - ◆ Anerkendt prøveinstitut i h. t. Delstatsbyggevædtagelserne, reg.nr.: NRW 15
 - ◆ Anerkendt prøveinstitut for byggeteknisk mæssige tilfælde
 - ◆ Anerkendt DIN CERTCO prøveinstitut, reg.nr.: PL139



PRØVNINGSATTEST

Kontrolerklæring nr RRF - 40 16 4259

Prøvens art Prøve i h. t. EN 13240:2001/A2:2004/AC:2007

Ordregiver: **Varde Ovne A/S**
Soldalen 12, 7100 Vejle, Danmark

Genstand for prøven: brændeovn
Series Varde Luna
Bolton
York, Cardiff, Bath, Lincoln, Liverpool, Glasgow

Nominel varmeydelse: 7,2 kW

Emissioner i forbrændingsprodukterne relateret til 13 % O₂.

| | | |
|-----------------|----------------------|--|
| CO-emissionen | 0,09 % | |
| Støvemissionen: | 16 mg/m ³ | efter CEN/TS15883, Annex A. 1 (DINplus metode) |
| OGC | 59 mg/m ³ | efter CEN/TS15883, Kapitel 4 |

Virkningsgrad: 80 %

CVR nr.: 21554979

P-nr.: 1005018532

Prøvningsresultater: Det attesteres herved at ovenfor nævnte fyringsanlæg opfylder emissionskravene i: Bilag 1 til bekendtgørelse nr. 46 af 22/01/2015 vedr. regulering af luftforurening fra fyringsanlæg til fast brændsel under 1 MW (1. og 2. trin)

Bemærk venligst, at de oplyste værdier er uddrag af prøvningsrapporten.

Godkendelsesafdelingens leder

Skorstensfejer påtegning

(Dipl. Ing. S. Müller)
Oberhausen, 27.04.2016

Dato, underskrift

Warranty

All **Varde** stoves go through a close quality inspection, and we take pride in always delivering products of a consistent quality. This being so, manufacturing faults may still occur, and on these we offer a **5 year warranty**.

The warranty does not include:

- wearing parts, such as the Vermiculite plates in the combustions chamber, the smoke plate, glass, gaskets, cast iron bottom and shacking grate.
- Damages whichs occur as a consequence of misuse, such as over-heating, incorrect installation, missing or wrong maintenance etc. (see instructions earlier)
- Damages caused by external influence of a physical character.
- Cost of transportation in connection with warranty repairs.
- Assembling/reassembling in connection with warranty repairs.
- Compensation for following damages, including damage on other objects.

Warranty conditions:

These instructions for use are also your proff of warranty. The warranty will not take effect until vendor's stamp, information about model, registration numer and date of purchase (invoice if possible) have been applid below. In case of claims, please bring this proof of warranty to your local vendor.

Model: _____

Reg.no.: _____

Date of purchase: _____



Vendor's stamp and signature



Soldalen 12, DK-7100 Vejle, Denmark, Tel. +45 7482 0003. vardeovne.dk