Varde Dallas
Houston
Irving
Seattle
Tacoma

**Installation— and
User guide**

Revision 1
UK



VARDE OVNE

Congratulation on purchasing your new stove

Varde Ovne A/S is a Danish company specializing in functional, environmentally friendly and designed quality stoves.

Important

Area beneath the stove must not be use to store wood or other flammable items

Index

Welcome and index	Page 2
Technical specifications Varde Dallas	Page 3
Technical specifications Varde Houston	Page 4
Technical specifications Varde Irving	Page 5
Technical specifications Varde Seattle	Page 6
Technical specifications Varde Tacoma	Page 7
Regulations and approval	Page 8
Flooring and distance	Page 9
Chimney	Page 10
Air supply	Page 11
Operation	Page 12
How to light and stoke a fire	Page 13
List of accessories	Page 14
Vermiculite	Page 15
How to choose the wood	Page 16
Maintenance	Page 17
Troubleshooting	Page 18
Spare Parts	Page 19
Fresh Air supply	Page 20
DOP	Page 21
Warranty	Page 22

Technical Specifications

Varde Dallas

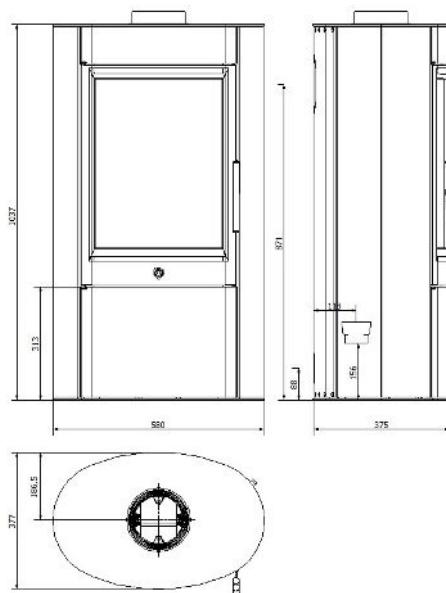

Model Dallas

Height (mm)	1037
Width (mm)	580
Depth (mm)	375
Weight (kg)	90
Effect	5,3-6W
Nominal Output	6 Kw
Heated area	30-105m ²
Efficiency	79 %

Flue gas data: 5,8g/sek., 265°C 20°C, 12 pa.

Combustion chamber: (H x W x D):

360 x 358 x 282mm

Flue outlet Ø 15 cm (Mounting height top:

~1037cm)

Distance to non-flammable: : 5-10cm
(recommended)

Distance to flammable materials:

Rear = 25cm, Sides = 30cm, In front = 90cm

Technical Specifications

Varde Houston

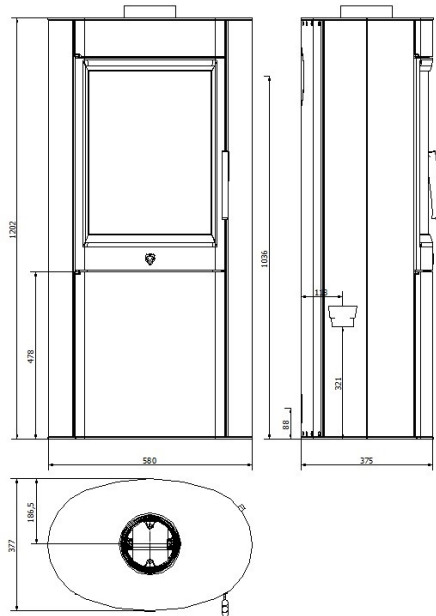

Model Houston

Height (mm)	1202
Wide (mm)	580
Depth (mm)	375
Weight (kg)	90
Effect	5,3-6W
Nominal Output	6 Kw
Heated area	30-105m ²
Efficiency	79 %

Flue gas data: 5,8g/sek., 265°C 20°C, 12 pa.

Combustion chamber: (H x W x D):

360 x 358 x 282mm

Flue outlet Ø 15 cm (Mounting height top:
~1037cm)

Distance to non-flammable: : 5-10cm
(recommended)

Distance to flammable materials:

Rear = 25cm, Sides = 30cm, In front = 90cm

Technical Specifications

Varde Irving

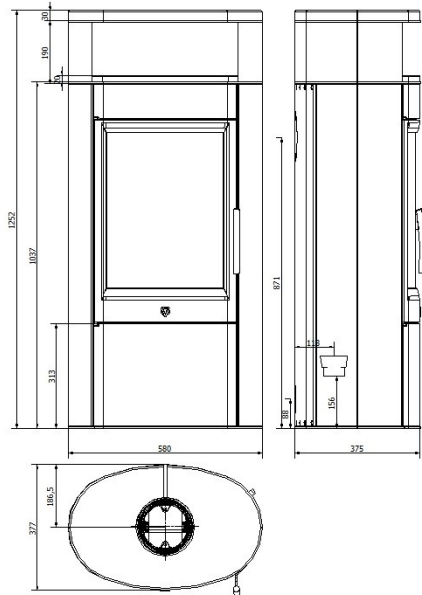

Model Irving

Height (mm)	1252
Wide (mm)	580
Depth (mm)	375
Weight (kg)	90
Effect	5,3-6W
Nominal Output	6 Kw
Heated area	30-105m ²
Efficiency	79 %

Flue gas data: 5,8g/sek., 265°C 20°C, 12 pa.

Combustion chamber: (H x W x D):

360 x 358 x 282mm

Flue outlet Ø 15 cm (Mounting height top:
~1037cm)

Distance to non-flammable: : 5-10cm
(recommended)

Distance to flammable materials:

Rear = 25cm, Sides = 30cm, In front = 90cm

Technical Specifications

Varde Seattle

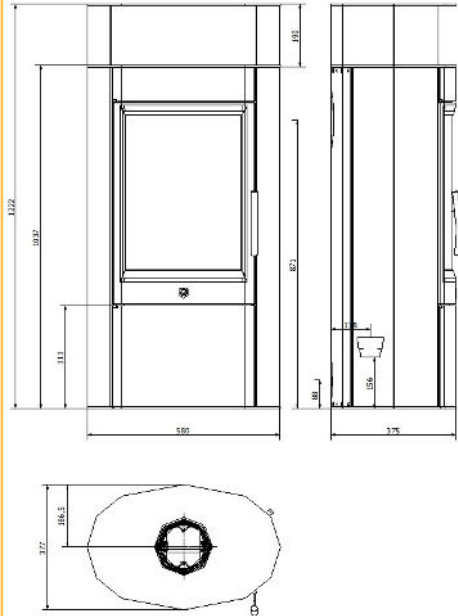

Model Seattle

Height (mm)	1222
Wide (mm)	580
Depth (mm)	375
Weight (kg)	90
Effect	5,3-6W
Nominal Output	6 Kw
Heated area	30-105m ²
Efficiency	79 %

Flue gas data: 5,8g/sek., 265°C 20°C, 12 pa.

Combustion chamber: (H x W x D):
360 x 358 x 282mm

Flue outlet Ø 15 cm (Mounting height top:
~1037cm)

Distance to non-flammable: : 5-10cm
(recommended)

Distance to flammable materials:

Rear = 25cm, Sides = 30cm, In front = 90cm

Technical Specifications

Varde Tacoma



Model Tacoma

Height (mm)	1607
Wide (mm)	580
Depth (mm)	375
Weight (kg)	90
Effect	5,3-6W
Nominal Output	6 Kw
Heated area	30-105m ²
Efficiency	79 %

Flue gas data: 5,8g/sek., 265°C 20°C, 12 pa.

Combustion chamber: (H x W x D):

360 x 358 x 282mm

Flue outlet \varnothing 15 cm (Mounting height top:

~1194cm)

Distance to non-flammable: : 5-10cm

(recommended)

Distance to flammable materials:

Rear = 25cm, Sides = 30cm, In front = 90cm

Important!

Before lighting up your **Varde Stove** for the first time, we recommend that you read these instructions carefully and contact your local stove vendor or building authorities to inquire about existing regulations regarding the installation of stoves. Please follow these regulations closely.

Inspection of installation

It is very important that the installation is inspected by a qualified chimney sweeper before the stove is used the first time.

This **Varde Stove**

Has passed the Danish /European Standard DS/EN 13240 Norwegian (NS), Austrian §15a Art. B-VG tests and the German (Stufe 2) test , and have thereby proved to be a environmentally friendly product.

Regulations

All local regulations as well as National and European, should be adhered to when installing your stove.

All Varde Ovne stoves are closed fireplaces.

The stove is designed for intermittent combustion and can be connected to a chimney used by other fireplaces, as long as the appropriate rules and regulations are adhered to.

Professional installation

We recommend that you consult with the dealer where you purchased the stove or an other competent installer, as there may be specific things to consider during the installation. You should also reseive the applicable rules for installing the stove and follow them.

Please Note!

You are by law required to register your stove at the local chimney-sweeper.

Until installation keep the stove dry and not to cold. The stove cannot stand moisture. That an existing chimney, not necessarily is effective enough for a new modern stove. Vermiculite is a very porous material, therefore handle with care. When refilling the stove, put the wood carefully, use the glove.

EC declaration of confirmaty.

MANUFACTURER

Name: **Varde Ovne A/S**
Adress: Pottemagervej 1, DK-7100 Vejle, Danmark

Test Institute

Name: **Rhein-Ruhr Feuerstätten Prüfstelle GmbH**
Adress: Im Lipperfeld 34 b, 46047 Oberhausen

Product

Product type: Varde Dallas, Houston, Irving, Seattle and Tacoma
Type code: Varde Dallas, Houston, Irving, Seattle and Tacoma
Standard: Heating stove, suitable for intermittent combustion
Costruction products (89/106/EC/) standard used
EN 13240
Application: Residential Heating
Fuel: Wood
Special conditions: Non

CE-Markning

Issued: 2015
Nominal Output: 6 kW
Fuel type: Wood
Fluegas temperature: 240 °C
Efficiency: 82 %
Co-release: 0,09 %

Jan Meldgaard
CEO

Varde Ovne

Flooring:

If the floor on which the stove is to be placed is inflammable, the floor must be covered with non-flammable material, such as steel or glass plate, floor tiles or artificial slate, covering an area of at least 15 cm from the sides of the stove and at least 30 cm from the front of it. Regarding the front, however, we recommend 50 cm. Also, the Floor construction must be capable of carrying the combined weight of stove and chimney.

Weight	Steel	With Soapstone	Accu
Varde Dallas	115 kg	-	-
Varde Houston	122 kg	-	-
Varde Seattel / Irving	122 kg	135 kg	-
Varde Tacoma	130 kg	-	210 kg

Installation distance:

If walls are non-inflammable, the stove can be placed closer to them. However, we recommend a minimum distance of 5-10 cm, to allow for cleaning behind the stove. The cleanout gate must be accessible. Optimal combustion can only be obtained if fresh air is constantly admitted. It is important, therefore, to ensure that this is the case. The best way to provide a steady flow of fresh air is by installing 1-2 air vent's in the room where the stove is situated. (One in each side of the room).

According to existing regulations, stoves must be placed with the following minimum distances in mm to inflammable walls and materials. The safety distance from a non-insulated chimney pipe to inflammable walls and materials must be at least 450mm.

Varde Vision

A	200 mm	C	250 mm
B	300 mm	D	300 mm
F	1000 mm	E	600 mm

The stove must in accordance with applicable rules comply with the following minimum distances from inflammable walls and materials:

Sides : 30 cm

Rear : 25 cm

Distance to furniture : 90 cm

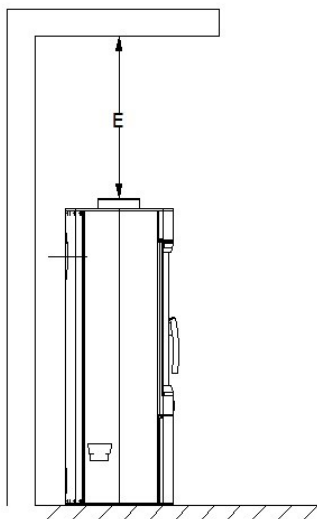
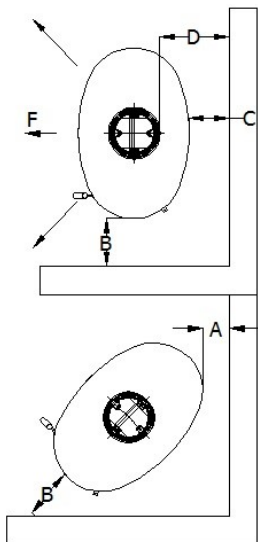

The chimney:

Always use a chimney with a diameter of at least 15 cm. This corresponds to a clear of 175 cm². Make sure the chimney is of a sufficient height, that it draws well and that smoke does not bother your neighbours.

We recommend that you fit your chimney with a damper, allowing for draft control. This may prove particularly important on windy days.

Note: the damper must never shut off draught completely – always allow at least 20 cm² free passage through the chimney.

With nominal usage the stove has tested a flue gas flow of 5,8g/second and with a flue gas temperature of 265°C and at a room temperature of 20 °C.

Varde stoves are always fitted with a smoke plate which redirects smoke to make its way to the chimney as effectively as possible. This ensures that the heat from the smoke is emitted inside your home rather than outside it. The smoke plate is moveable and placed in top of the Combustion Chamber. You should make sure that it is pushed all the way back against the back wall of the combustion chamber.

Draught conditions

Consult your local stove dealer about how best to adjust the draught in your chimney.

Height of chimney

If in doubt, contact your local stove dealer. He will be able to inform you of the correct height.

Connection of Flue pipe:

The Stove is mounted with Flue adaptor on top or on the rear side.

When mounting on the rear side the Flue adaptor and cover switch places.

The cast iron cover is placed in the hole on **in** top of the cast iron top.

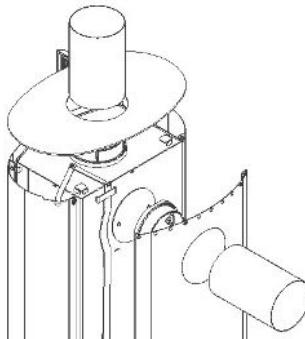

Information about the new cast iron adapter

Your stove is equipped with the new cast iron adapter from Varde Ovne.

The adapter is suitable for smoke pipes with inner diameter on 150 mm.

If you need it, it's now possible for you to make a condensate drain-hole in the adapter.

Carefully punch a chisel or the like through the bottom of the outer groove (at the arrow mark). This way you can establish a condensate drain hole in the adapter if needed

Arrow mark for the hole.

Carefully punch a hole with a chisel or the like.

Now the condensate – hole is ready.

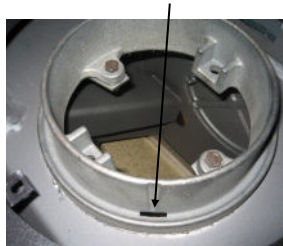
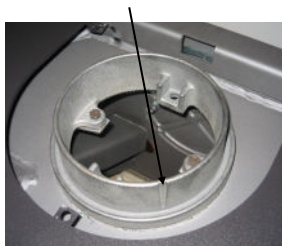

How it works — Operation

Ignition/ Lighting your Varde Ovne stove

1.:
Open the Ignition Air by
turning the handle **1** down.

2.:
Push the Combustion air
Throttle **2** towards left for
Air Inlet.

Your stove is now in igni- tion position.

Once the fire has caught
properly, push handle **1** up.

Your stove is now in op- erating position.

Wait until the fire burns
bright and clear.
Regulate the fire/heating by
pushing the Throttle from
left towards right.

The Shake grate is
operated by moving
the handle inn and
out .

**Normally operation
of the Stove.
The handle should
be in the inner posi-
tion. The grate must
be closed.**

Combustion Air Throttel

Turn the Throttel towards left for Air
Inlet. Turn towards right to close.

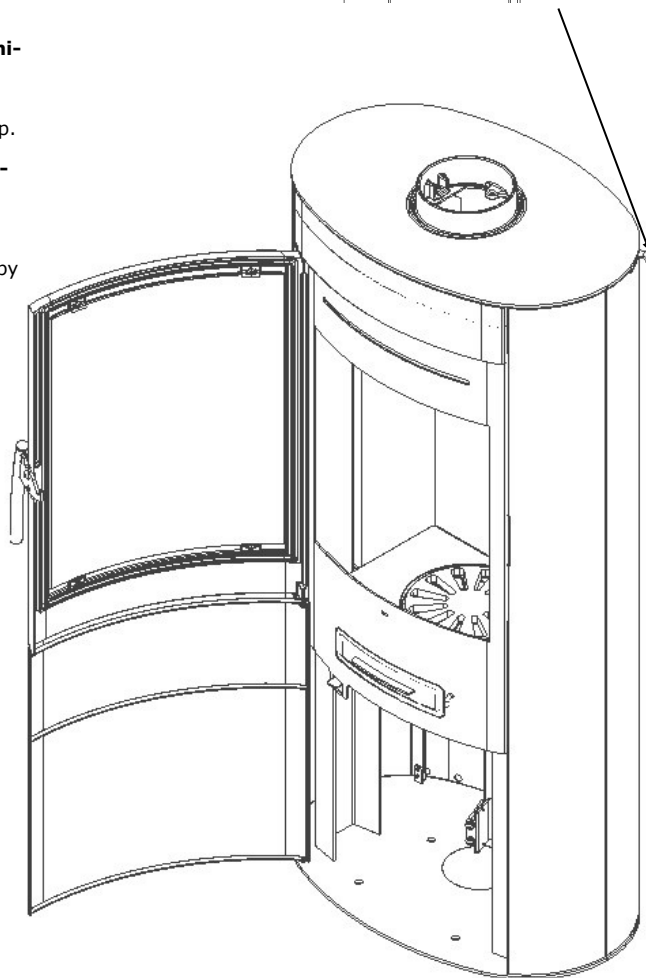
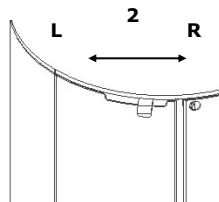

Ignition Air-is closed
when the handle is
pushed up.

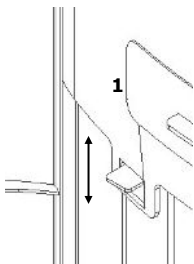

How to light and stoke a fire

The first time you light up the stove, the enamel will temper and give off some smoke and a slightly burnt smell. We recommend that you leave doors and windows open, as airing the room will make the smell disappear.

This tempering softens the enamel, making it susceptible to damage. Therefore exercise caution and avoid touching the enamel. We also recommend opening the door to the stove at regular intervals during the first couple of hours to prevent the rope seal from sticking to the enamel.

Never use highly flammable liquids such as methylated spirit or petrol for lighting up!

We recommend using 'top-down' lighting, where you light the wood at the top of the combustion chamber and not at the bottom. This is the most environmentally friendly method to light a fire. The method will also help keep the glass clean. Place two small logs in a cross on the bottom plate of the combustion chamber (approx. 1.3 kg) with a small distance between each log. Place 10 – 15 smaller sticks (approx. 1.3 kg) in a cross on top of the logs, and 2 – 3 firelighters at the top and in between the sticks.

A thin layer of ash at the bottom of the stove makes it easier to light the fire.

Before lighting the stove, open the **ignition air** (See page 10 for how)

Once the fire burns, remember to close the ignition air vent and shaking grate again. Otherwise, the stove and chimney might become overheated, which would invalidate the warranty.

A slight amount of soot may build up on side glass during the start-up fire. This is normal and vanishes after a period.

Once the kindling has reduced to embers, we recommend opening the door slightly for a couple of seconds to neutralise the negative pressure in the combustion chamber before opening the door completely.

Place 2 logs in a cross on top of the embers (approx. 1.3 kg) and close the door again. To make sure the wood ignites quickly, we recommend briefly opening the ignition air vent and make sure you remember to close it again once the fire gets going. You can then adjust the combustion air according to your heating requirements.

Take care not to shut off the air supply completely, otherwise the fire will die. The fire should always burn bright and clear.

In most instances, however, you will have to identify the **best combustion air settings** yourself, as the height and draught of your chimney as well as the quality of the firewood are decisive factors in determining the best settings for your particular stove.

If the nominal heat output of your stove is too high compared to your heating requirements, you can reduce the output as follows:

- Stoke a smaller amount of wood than usual, for example 1 kg, preferably consisting of 3 – 4 smaller pieces of wood. Apply full air to ignite the wood properly before reducing the combustion air, perhaps down to approx. 60%. Be careful not to reduce the air supply to the point that the fire dies. The fire should always burn bright and clear.

With this method it is possible, depending on the chimney, wood quality, etc., to reduce the stove's heat output from a nominal 5 kW down to perhaps 3 kW.

Please be aware that it can lead to poor combustion if you reduce the combustion air too much, resulting in a lower efficiency and increased emission levels (increased pollution).

When refilling the stove with wood, we recommend opening the stove door once only embers are left in the combustion chamber. Opening the door while flames are still burning and producing smoke and gas might cause smoke to escape into the room.

If you have problems lighting or operating the stove, see the section on **Troubleshooting**.

Operation

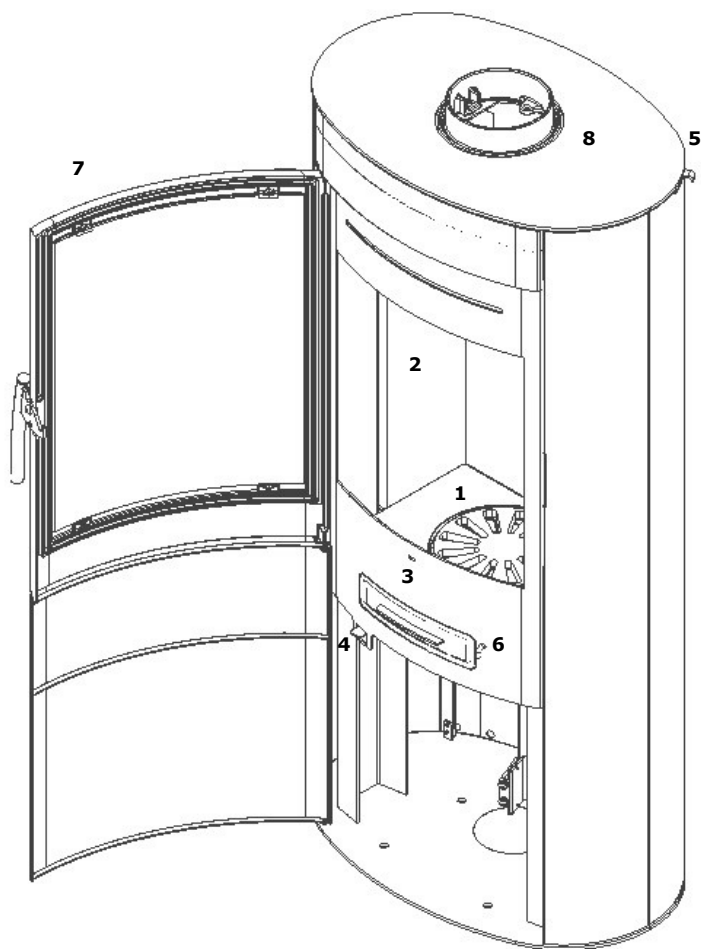

1. Shake grate
2. Vermiculit plates
3. Ash tray
4. Ignition Air
5. Combustion Air
6. Throttlet for Shake grate
7. Cast iron Door
8. Top Steel cover

Vermiculite

The plates in the combustion chamber are called **vermiculite plates** and will eventually become worn, as will the smoke guide plate. Accidental breakage of a plate, for instance by hitting it hard with a piece of wood, will not affect the quality of the combustion. You do not need to replace the plate until the gap is approx. 5 mm wide.

Vermiculite

A special, non-flammable material that looks like chipboard. The plates act as insulation and at the same time protect the stove against wear and tear. The vermiculite plates and the smoke guide plate are not covered by the warranty.

Vermiculite is a **very porous** material and should be handled with care. When refilling the stove, stoke the wood carefully and use a glove.

Only use original parts from Varde Ovne A/S

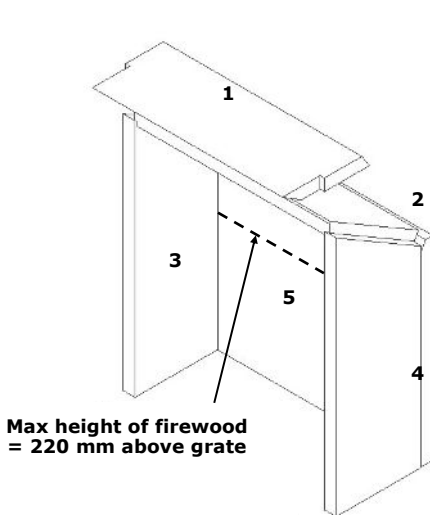

**Max height of firewood
= 220 mm above grate**

**Vermiculit set,
Item no.: 100307**

- 1. Smoke guide**
- 2. Air guide**
- 3. Left side plate**
- 4. Right side plate**
- 5. Rear**

How to replace the Vermiculite

1. Lift the left side plate slightly and rotate outwards.
2. Lift the right side plate and rotate outwards.
3. Lift the rear plate up and out of the stove.
4. Air Guide, tilt and remove.
5. Lift the smoke guide slightly, tilt the rear end forward and remove.

When fitting the new vermiculite plates, begin with the Smoke guide and repeat the steps in the reverse order, finishing with step 1

What kind of wood to use?

Generally, beech wood is considered the best type of wood for burning. It burns evenly without producing much smoke and ashes are clean and take up little space. Ash, birch and maple wood are fine alternatives.



How big the firewood?

Split firewood with a diameter larger than 10 cm. Use firewood with a length on 20-25 cm. The use of larger quantities of fuel than recommended in the tabel below will overtax the stove and resulte in increased temperatures in the chimney as well as a lowered efficiency. This may cause damage to both chimney and stove, and the annulment of the warranty. Also, never use toxic materials such as chipboard, painted or impregnated wood.

Kindling

Lenght: 25 –30 cm
 Diameter: 2-5 cm
 Amount per firing: 1,3 kg
 (approx. 10-12 finely chopped pieces)

Feeding Wood: Chopped wood

Lenght: 25-30 cm
 Diameter: 7-9 cm
 Normal amount: 1.3 kg/hour (2 pieces)
 Max amount: 2.0 kg/hour (max 3 pieces per insertion. Max 1.5 kg per insertion)

The new stove

The first time you light up the stove the enamel will temper, and give off some smoke and a slight smell. We recommend that you leave doors and windows open, as airing the room will make the smell disappear. This tempering softens the enamel making it susceptible to damage. Therefore exercise caution and avoid touching the enamel. Likewise we recommend opening the door to the stove at regular intervals for the first hours to prevent the insulations rope from sticking to the enamel.

What to burn.

This Varde Stove is tested and approved for the burning of wood. Only dry wood with a moisture content of maximum 20 percent and the size to fit into the combustion chamber should be used. The burning of moist wood will result in an increased amount of tarry soot, pollution and uneconomic fuel consumption. Newly chopped wood contains about 60-70 percent moisture, which makes it completely unsuitable as fuel. Allow newly chooped firewood to dry in a open shed for a couple of years before using it in the stove.

Do not use! - Consider the environment

Also, never use toxic materials such as chipboard, painted or impregnated wood.

The use of larger quantities of fuel than recommended in the tabel below will overtax the stove and resulte in increased temperatures in the chimney as well as a lowered efficiency. This may cause damage to both chimney and stove, and the annulment of the warranty.

Topdown lightning



The following optimal register and fuel quantity settings are recommended(in case of similar chimney draught):

Fuel Quantity [kg]	Primary Air open [%]	Combustion Air open [%]	Nominal Output [kW]	Chimney Draught [PA]	Efficiency [≥ i %]	Refill interval at nominal output [minuts]
1,3	0 (closed)	ca. 50 (almost open)	6,1	12	82 %	ca. 45

Maintenance

Like any piece of equipment in daily use, your stove needs maintenance.

The stove should only be cleaned when cold. Use a dry cloth for cleaning the exterior of the stove.

Clean the interior regularly by removing ashes, soot and tar from the combustion chamber. The smoke deflector plate should be removed for cleaning, as the reverse side will be covered in dirt and soot. Finally check that the smoke pathway through the flue pipe and chimney is completely clear. You should also inspect the rope seals in the door and ash pan for signs of wear. Replace them if they no longer seal properly. Also, remember to lubricate the door hinges as required.

Glass pane

The glass pane should be cleaned using Varde Glas Cleaner, which is available at all DIY centres selling **Varde Ovne stoves**.

Empty the **Ash pan** regularly. It can be emptied into your dustbin, as long as you make sure it does not contain any hot embers. If in doubt about how to clean your stove, contact the dealer where you bought your stove, or your chimney sweeper.

It is especially important to check the stove and the chimney for blockages after a long period of non-use.

The enamelled surface of the stove may wear down in certain places if the stove is **overheated**. Worn surfaces can, however, be repaired with a special Senotherm[®] spray paint, available from your local dealer.

The plates in the combustion chamber are **vermiculite plates** and will eventually become worn, as will the smoke deflector plate. Accidental breakage of a plate, for instance by hitting it hard with a piece of wood, will not affect the quality of the combustion. You do not need to replace the plate until the gap is 5 mm wide.

Only use original parts from Varde Ovne A/S

The door is equipped with a spring, which pulls the gate closed. This is a legal requirement in many countries. The spring is fitted to the hinged side of the door but can be removed if you prefer the door not to be spring-loaded.

Do not make any unauthorised changes to the stove.

All external parts of the stove become hot during use, and you should therefore exercise due caution.

IMPORTANT!!

Chimney fires

Should your chimney catch fire, cut off the air supply to the stove's combustion chamber and contact the emergency service. (The majority of fires die out after the oxygen supply is cut off.) You should subsequently contact your chimney sweeper, who will check your stove and chimney for damage

Troubleshooting.

Smoke enters the room

- Not enough draught in the chimney.
- Inspect the flue pipe or the chimney for blockage.
- Make sure the **height of the chimney** is correct.

The glass or the chimney soots up

- The wood is too moist.
- Not enough secondary air is supplied to the combustion process.
- You may have shut off the supply of ignition air too soon when lighting the stove.
- There should be clear flames in the combustion chamber at all times.

No heat is emitted from the stove

- The wood is too moist (all energy is spent on drying it) or of a poor quality.
- Inspect the position of the smoke deflector plate and make sure there is free passage for the smoke.
- The amount of combustion (secondary) air is insufficient.

Combustion is too intense

- Rope seals in the door or the ash pan are no longer tight and need replacement.
- The chimney draught is too strong; install a damper in the chimney.
- Check that the ignition air is shut off.

The shaking grate is stuck

- Inspect the grate for jammed wood, nails or the like.
- Make sure the lever is placed correctly.

Recycling



Packaging

For environmental reasons, the packaging should be disposed of together with household waste. The packaging is 100% recyclable.

Ceramic glass

Ceramic glass should be deposited at the local recycling centre (together with pottery and porcelain).

Vermiculite

Vermiculite plates from the stove should be deposited at the local recycling centre.

Spare Parts

If Spare parts at any time should be needed, please check the list below.

Vermiculit Set, Item no.: 100307

Glas, Item no.: 100683

Sealings—Door , Item no.: 100351

Shake Grate, Item no.: 100471

Glass spring with screws, Item no.: 100359

Continual fresh air.

A continual supply of fresh air is required in the room in which the stove is situated. This can be achieved by installing 1 or 2 vents, whilst also ensuring that these can not be blocked.

Combustion air supply (extra)

When a stove is installed in a room, the requirements to air supply increase. The air can be supplied through a vent in the outer wall or through a duct from the outside that is attached to the connector underneath the stove. The quantity of air needed for combustion is approx. 20 m³/h.

The spigot has an outer diameter of 67 mm. With pipes longer than 1 m the pipediameter has to be increased to 100 mm, and equivalent larger wall vent is chosen.

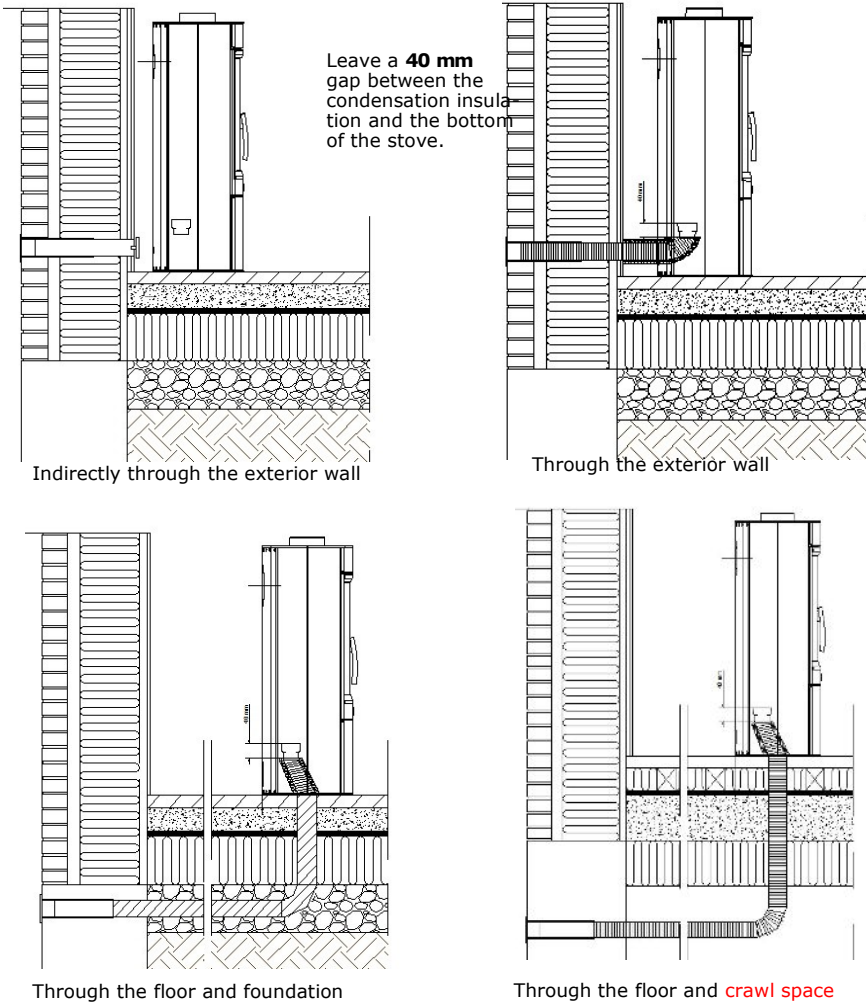



DECLARATION OF PERFORMANCE

No.:	1	Company's name:	Varde Ovnie
REVISION:	3	Address:	Soldanen 12
DATE OF ISSUE:	02-10-2013	Zip Code:	7100
		Country:	DK

STOVE INSPECTION:

WRITTEN BY: PM René Schultz
APPROVED BY: CEO Jan Meldgaard

PRODUCT NAME:	Houston, Dallas, Seattle, Irving & Tacoma	
Room heaters for solid fuel:	Test DIN EN 13240: 2001/AC:2008/DIN EN 13240:2001/A2:2004/AC:2007	Test Art. 16a B-VG
STOVE APPROVAL PLACE:	TEKNOLOGISK INSTITUT Kongsvangs Alle 29 8000 Århus C DK Notfield Body Number 1235	
STOVE APPROVAL PLACE:	RRF Im Lippertfeld 34b D-46047 Oberhausen Notfield Body Number 1625	

System or systems of assessment and verification of consistency of performance of the construction products as set out in Annex V:

System 3

Fire Safety:

Harmonized technical specifications:

Distance from inflammable materials:

Minimum distances in mm:

Back: 960

Sides: 260

Front: 1000

Reaction to fire	A1	
Emission of the combustion products:	13% CO	
CO	0,09%	1125 mg/m ³
OGC	43 mg/MJ	72 mg/m ³
Dust:	19 mg/MJ	28 mg/m ³
Nox	94 mg/MJ	144 mg/m ³
Surface temperature:	OK	
Electrical Safety:	---	
Cleanability:	OK	
Flue gas temperature at rated output:	240 C.	
Mechanical craft (to carry a chimney):	OK	
Heat output:		
Nominal heat output:	6.0KW:	
Space heating output:	6.0KW:	
Water heating capacity:	---	
Efficiency:	82%	

Signed for and on behalf of manufacture by:

Signature CEO:

Jan Meldgaard





Revision	Date of revision
1	02-12-2013
2	17-12-2013
3	06-05-2015

Warranty

All **Varde** stoves go through a close quality inspection, and we take pride in always delivering products of a consistent quality. This being so, manufacturing faults may still occur, and on these we offer a **5 year warranty**.

The warranty does not include:

- wearing parts, such as the Vermiculite plates in the combustions chamber, the smoke plate, glass, gaskets, cast iron bottom and shacking grate.
- Damages which occur as a consequence of misuse, such as over-heating, incorrect installation, missing or wrong maintenance etc. (see instructions earlier)
- Damages caused by external influence of a physical character.
- Cost of transportation in connection with warranty repairs.
- Assembling/reassembling in connection with warranty repairs.
- Compensation for following damages, including damage on other objects.

Warranty conditions:

These instructions for use are also your proff of warranty. The warranty will not take effect until vendor's stamp, information about model, registration numer and date of purchase (invoice if possible) have been applid below. In case of claims, please bring this proof of warranty to your local vendor.

Model: _____

Reg.no.: _____

Date of purchase: _____



VARDE OVNE

Vendor's stamp and signature



Pottemagervej 1, 7100 Vejle, Danmark. WWW,vardeovne.dk